

**COLOR
TELEVISION**

**Xentia 32
LXW 82-8625 IDTV
Xentia 37
LXW 94-8625 IDTV**

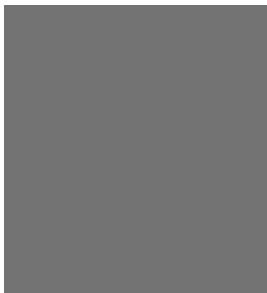

GRUNDIG

Contents

Installation	3	Installation Menu	33
Remote control handset	4-5	Other Menu	34
Controls	4	Connection of PC	35
Battery installation	5	PIP (Picture-In-Picture) Feature	36-37
Controls of		Watching PIP	36
Front panel	6	PIP Audio input	36
Connections of		Moving the PIP	37
Back panel	7	Sub picture size	37
Connection to		Programme scan	37
External equipment	8-12	Information Menu (In Digital mode only)	38
Basic operation		Teletext	39-40
On and Off	13	Displayable Monitor Specification	41
Programme selection	13	Troubleshooting	
Volume adjustment	13	Check list	43
On screen language selection	13		
On screen menus			
Menu selection	14		
Setting up TV stations	15-23		
Sound adjustment	15-18		
Picture adjustment	19-21		
Child lock	22		
Timer	23-25		
DTV option Menu (in digital mode only)	26-29		
Preset list Menu	30-32		

Power

This set operates on an AC mains supply, the voltage is as indicated on the label on the back cover. Never apply DC power to the set. In the event of thunderstorms or power-cuts, please pull out the aerial and mains plugs.

Warning

To prevent fire or shock hazard, do not expose the set to rain or moisture. Do not rub or strike the Active Matrix LCD with anything hard as this may scratch, mar, or damage the Active Matrix LCD permanently.

Service

Never remove the back cover of the set as this can expose you to very high voltage and other hazards. If the set does not operate properly, unplug it and call your dealer.

Aerial

Connect the aerial cable to the socket marked U75 on the back cover. For the best reception an outdoor aerial should be used.

Location

Position your set so that no bright light or sunlight falls directly onto the screen. Care should be taken not to expose the set to any unnecessary vibration, moisture, dust or heat. Also ensure that the set is placed in a position to allow a free flow of air. Do not cover the ventilation openings on the back cover.

Cleaning

Unplug the set before cleaning the face of the LCD Screen. Dust the set by wiping the screen and the cabinet with a soft, clean cloth. If the screen requires additional cleaning, use a clean, damp cloth. Do not use liquid cleaners or aerosol cleaners.



To preserve the Environment,
do not rubbish.

Remote control handset Controls

- All the functions can be controlled with the remote control handset.
- Some functions can also be adjusted with the buttons on the front panel of the set.

NUMBER BUTTONS

i BUTTON
selects a menu.

▲ / ▼ (Programme Up/Down)
selects a programme or a menu item.
switches the set on from standby.

◀ / ▶ (Volume Up/Down)
adjusts the volume.
adjusts menu settings.

OK
accepts your selection or displays the current mode.

TELETEXT BUTTONS
These buttons are used for teletext.
For further details, see the 'Teletext' section.

SCAN
switches on the programme scan mode through 4/16 sub pictures.
Display the TV Guide in digital mode.

PAP (Picture And Picture)
selects the double window function.

PSM (Picture Status Memory)
recalls your preferred picture setting.

SIZE
adjusts the sub picture size.

VCR, SAT, DVD
Switches to operating a GRUNDIG video recorder, a GRUNDIG satellite receiver or a GRUNDIG DVD player.
Keep the appropriate button **VCR, SAT, DVD** pressed down. Then press the appropriate button

POWER
switches the set On from standby or Off to standby.

PIP
Switches the sub picture On or Off.

ARC
select your desired picture format.
page stop in teletext mode.

SLEEP
sets the sleep timer.
select a sub page number in teletext mode.

MUTE
switches the sound On or Off.

Zap function
returns to the previously viewed programme.

AV INPUT
Select DTV, TV, AV1, AV2, S-VIDEO, COMPONENT, PC-RGB, HDMI mode.
switches the set on from standby.

PIP POSITION
relocates the sub picture in clockwise direction.

SSM (Sound Status Memory)
recalls your preferred sound setting.

STILL
freezes motion of the sub picture.

TIME
Display the time at the screen.
Selects a favourite programme add and delete in digital mode.

- COLOURED BUTTONS
These buttons are used for teletext (only TELETEXT models) or programme edit.

GRUNDIG
Tele Pilot 160A

Note : The functions available depend on the model of the device you are using.
Just try it out.

Before you use the remote control handset, please install the batteries.

Remote control handset

Battery installation

- Your remote control handset is powered by two AA type batteries.



- To insert batteries, turn the remote control handset over and remove the battery cover.
- Put the two batteries into the compartment observing battery polarity.
- Replace the cover.

To avoid damage from possible battery leakage, remove the batteries if you do not plan to use the remote control handset for an extended period time. Do not use batteries of differing age or type. Always discard of batteries safely.

Controls of Front panel

- Shown is a simplified representation of the set.
- Here shown may be somewhat different from your set.
- This manual explains the features available on the Xentia series.

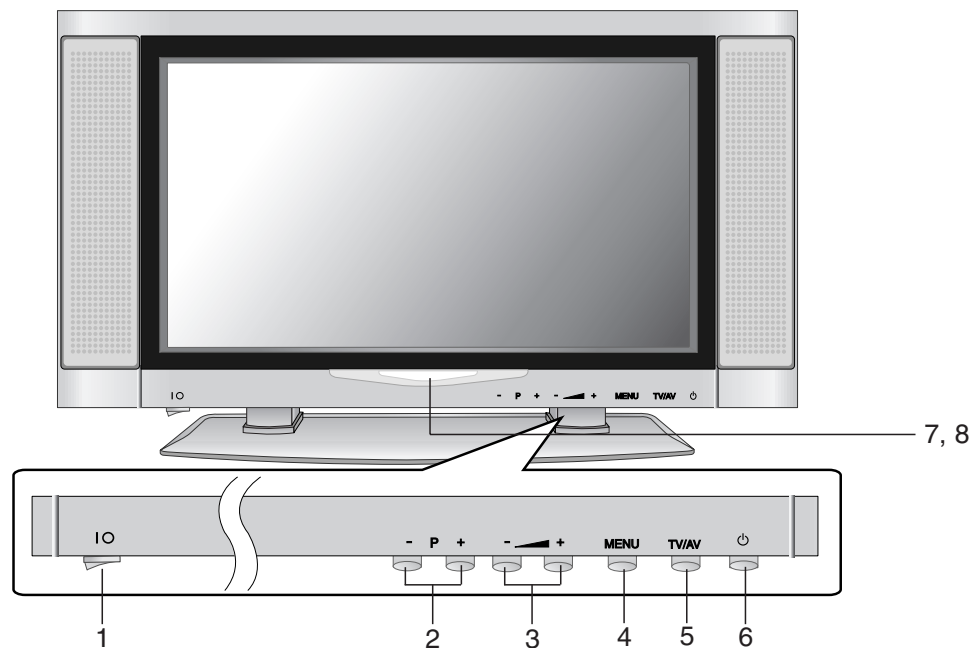

1. MAIN POWER (I/O)
switches the set On or Off.

2. ▲ / ▼ (Programme Up/Down)
selects a programme or a menu item.
switches the set On from standby.

3. ◀ / ▶ (Volume Down/Up)
adjusts the volume.
adjusts menu settings.

4. MENU
selects a menu.

5. TV/AV
selects **DTV, TV, AV1, AV2, S-VIDEO, COMPONENT, PC-RGB, HDMI** mode.

6. POWER (⏻)
switches the set On from standby or On to standby.

7. POWER/STANDBY INDICATOR (⏻)
illuminates red in standby mode.
illuminates green when the set is switched On.

8. REMOTE CONTROL SENSOR

Connections of Back panel

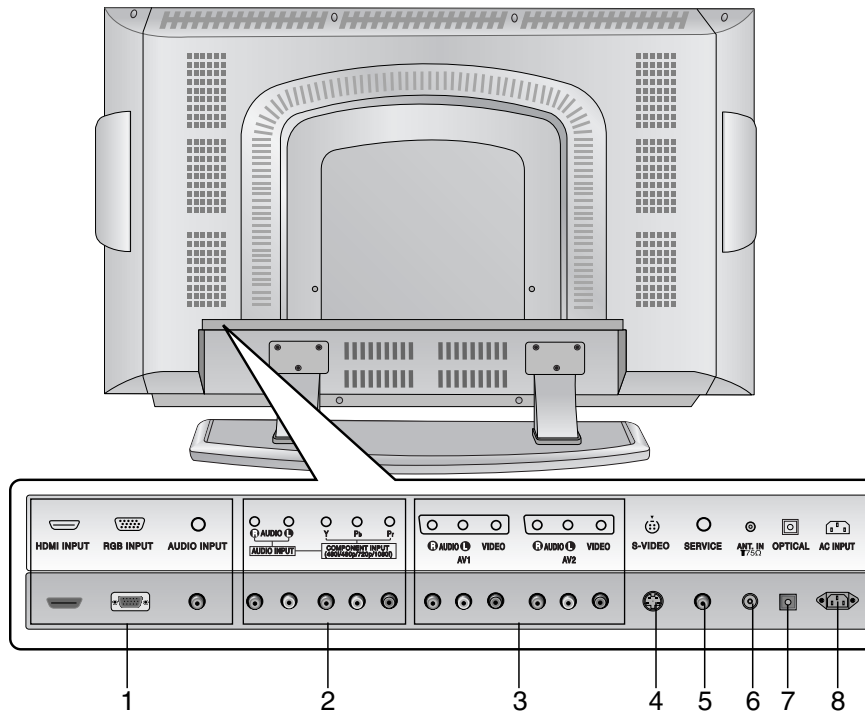

1. **HDMI INPUT / RGB INPUT / AUDIO INPUT SOCKETS**
Connect the set output socket of the PERSONAL COMPUTER to this socket.
2. **AUDIO INPUT / COMPONENT INPUT (480i / 576i / 480p / 576p / 720p / 1080i) SOCKETS**
3. **AUDIO/VIDEO SOCKET**
Connect the audio/video out sockets of the VCR to AV sockets of the set.
4. **S-VIDEO INPUT**
connect video out from an S-VIDEO VCR to the S-VIDEO input.

5. **SERVICE SOCKET**
6. **AERIAL SOCKET**
7. **Digital Audio (OPTICAL)**
Connect digital audio from various types of equipment.
Note : In standby mode, these ports will not work.
8. **POWER CORD SOCKET**
This set operates on an AC power. The voltage is indicated on the Specifications page. Never attempt to operate the set on DC power.

Connection to External equipment

- You can connect additional equipment, such as VCRs, camcorders etc. to your set. However please check with your manufacturers instruction books for specific information. Make sure all connections are made with both your set and additional appliance unplugged from the mains to avoid damaging your equipment. Here shown may be somewhat different from your set.

1 Connect to Aerial socket

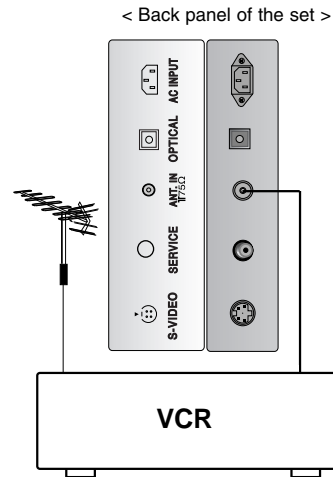

Connect the RF out socket of the VCR to the aerial socket on the back of the set.

Connect the aerial cable to the RF aerial in socket of the VCR.

Store the VCR channel on a desired programme number using the 'Manual programme tuning' section.

Select the programme number where the VCR channel is stored.

Press the **PLAY** button on the VCR.

2 Watching VCR

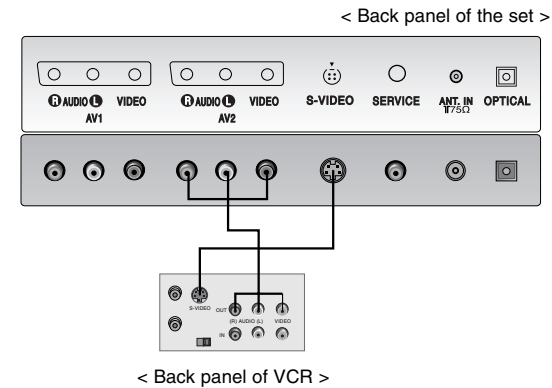

- If you connect an S-VIDEO VCR to the S-VIDEO input, the picture quality is improved; compared to connecting a regular VCR to the Video input.

- To avoid picture noise (interference), leave an adequate distance between the VCR and set.

Use the **INPUT SELECT** button on the remote control to select **AV1** or **AV2**.

(If connected to S-VIDEO, select the **S-Video** external input source.)

Insert a video tape into the VCR and press the **PLAY** button on the VCR. (See VCR owner's manual)

Connection to External equipment

3

Watching Cable TV

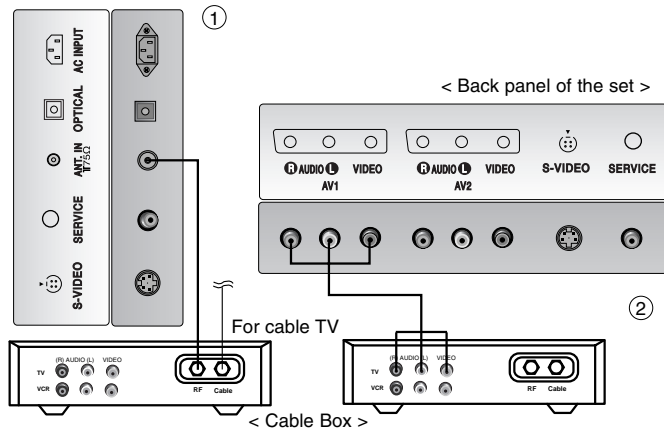

- After subscribing for a local cable TV station and installing a converter you can watch cable TV.
- For further information of cable TV, contact the local cable TV station.

In using connection 1

Select programme number in programme switch of cable box.
Match the set programme with selected programme of cable box.
Select your desired programme with the remote control for cable box.

In using connection 2

Use the **INPUT SELECT** button on the remote control and select **AV1** or **AV2**.

Tune to cable service provided channels using the cable box.

4

Watching external AV source

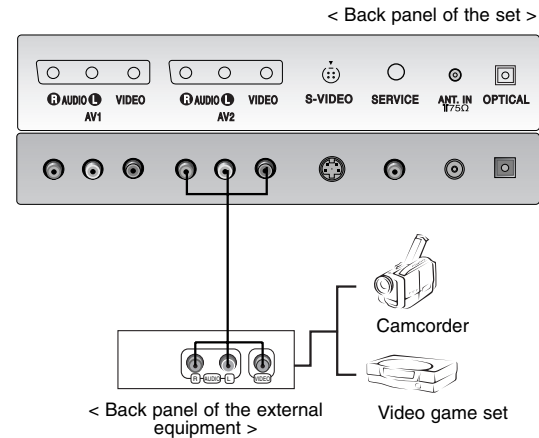

When connecting the set to an external source, match the colours of AUDIO/VIDEO input jacks on the set with the output jacks on the audio/video equipment: Video = yellow, Audio (Left) = white, Audio (Right) = red.

Use the **INPUT SELECT** button on the remote control to select **AV1** or **AV2**.

Operate the corresponding external equipment.
See external equipment operating guide.

Connection to External equipment

5 Watching DVD

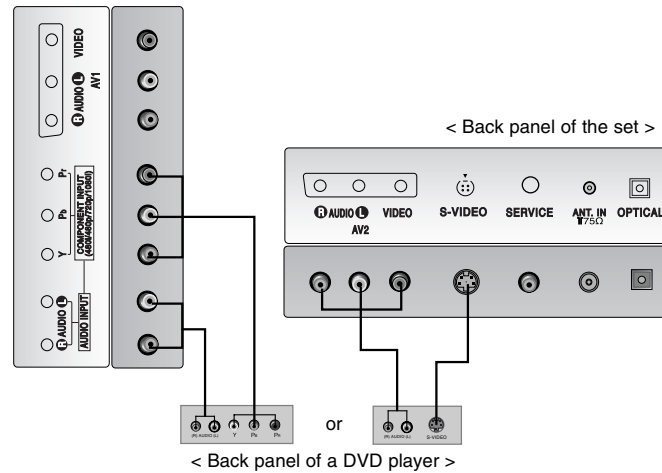

How to connect

Connect DVD video inputs to Y, PB, PR of COMPONENT (DVD INPUT) and audio inputs to Audio sockets of AUDIO INPUT.

How to use

Turn on the DVD player, and insert a DVD.

Use **INPUT SELECT** button on the remote control to select **Component**. Refer to the DVD player's manual for operating instructions.

• Component Input ports

You can get better picture quality if you connect DVD player with component input ports as below.

Component ports of the set	Y	P _B	P _R
Video output ports of DVD player	Y	P _b	P _r
	Y	B-Y	R-Y
	Y	C _b	C _r
	Y	P _B	P _R

Connection to External equipment

6

Connecting HDMI

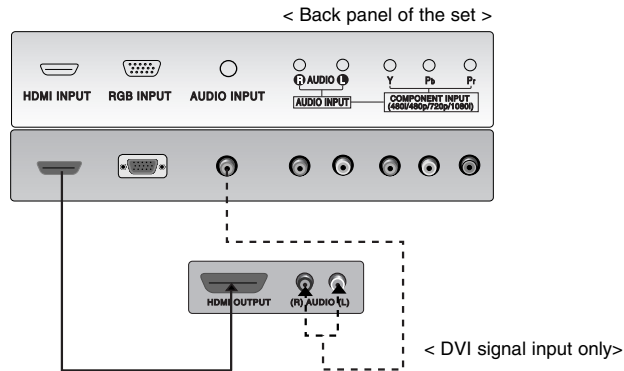

Connect the signal cable from the monitor output socket of the DVD player or Set top Box to the **HDMI INPUT** socket of the set.

Connect the audio cable from the PC to the **AUDIO INPUT** sockets of the set.

Press the **INPUT SELECT** button to select **HDMI**.

Switch on the HDMI, and the HDMI screen appears on the set.

HDMI input signal : 480p-60Hz, 576p-50Hz, 720p-50Hz, 720p-60Hz, 1080i-50Hz, 1080i-60Hz.

HDMI Interface with HDCP Copy Protection enables all-digital rendering of video without the losses.

This TV SET can receive the High-Definition Multimedia Interface(HDMI) or Input of Digital Visual Interface(DVI).

Connection to External equipment

7 Connecting PC

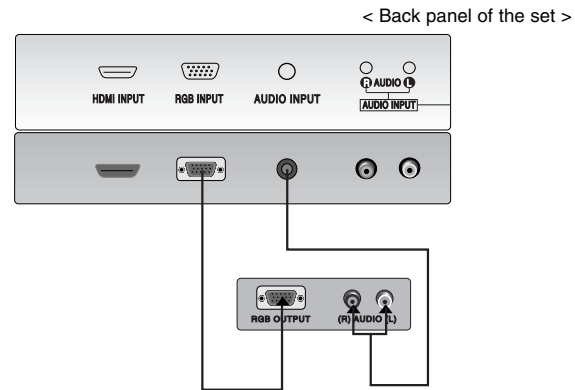

Connect the signal cable from the monitor output socket of the PERSONAL COMPUTER to the **RGB INPUT** socket of the set.

Connect the audio cable from the PC to the **AUDIO INPUT** sockets of the set.

Press the **INPUT SELECT** button to select **PC-RGB**.

Switch on the PC, and the PC screen appears on the set.

The set can be operated as the PC monitor.

RGB input signal : 480p-60Hz, 576p-50Hz, 720p-50Hz, 720p-60Hz, 1080i-50Hz, 1080i-60Hz.

8 Connecting Digital Audio

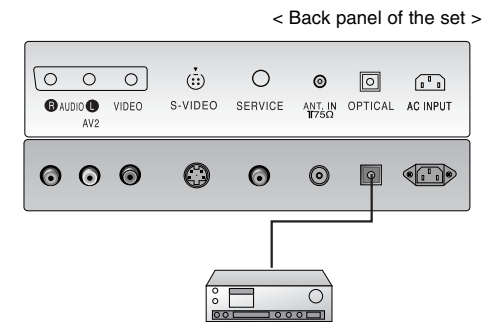

- Send the set's audio to external audio equipment (stereo system) via the Digital Audio Output (Optical)

Caution : Do not look into the optical output port. Looking at the laser beam may damage your vision.

How to connect

Connect one end of an optical cable to the TV Digital Audio (Optical) Output port.

Connect the other end of the optical cable to the digital audio (optical) input on the audio equipment.

Note : Digital Audio Output works, when it's inputted HDMI signal to the set.

1

On and Off

Press the main power button to switch the set on.

If the set is in standby mode, press the **POWER**, **▲ / ▼** buttons on the remote control handset to switch it on fully.

Press the **POWER** button on the remote control handset.

The set reverts to standby mode.

Press the main power button again to switch the set off.

2

Programme selection

You can select a programme number with the **▲ / ▼** or **NUMBER** buttons.

3

Volume adjustment

Press the **◀ / ▶** button to adjust the volume.

If you want to switch the sound off, press the **MUTE** button. You can cancel it by pressing the **MUTE**, **◀ / ▶**, **⊗** button.

4

On screen language selection

Press the **i** button and then use **▲ / ▼** button to select the Installation menu.

Press the **OK** button and then use **▲ / ▼** button to select **Language**.

Press the **OK** button and then use **▲ / ▼** button to select your desired language.



All the on screen displays will appear in the selected language.



Press the **i** button to return to normal TV viewing.

On screen menus





Menu selection



- The dialogue between you and your set takes place on screen with an operator menu. The buttons required for the operating steps are also displayed.

1
Press the  button and then use  /  button to display each menu.

2
Press the **OK** button and then use  /  button to select a menu item.

3
Press the **OK** button to display the sub menu or the pull-down menu.

4
Change the setting of an item in the sub or pull-down menu with  /  or  / .

You can move to the higher level menu with  button and to move to the lower level menu press the  button.

Note : *Menus may vary according to input mode.*

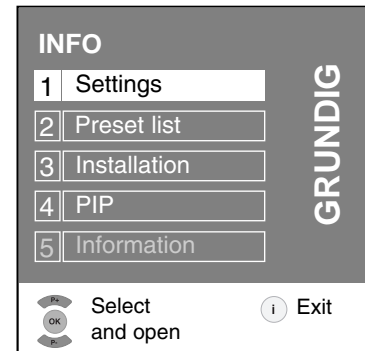

Setting up TV stations

Sound adjustment

1 Sound mode

Press the **i** button and then use **▲ / ▼** button to select the Settings menu.

Press the **OK** button and then use **▲ / ▼** button to select **Sound**.

Press the **OK** button and then use **▲ / ▼** button to select **Sound mode**.

Press the **OK** button and then use **▲ / ▼** button to select the desired sound item.

Press the **i** button to return to normal TV viewing.

Language selection for dual language broadcast

If a programme received in two languages (dual language).

DUAL A sends the primary broadcast language to the loudspeakers.

DUAL B sends the secondary broadcast language to the loudspeakers.

DUAL AB sends a separate language to each loudspeaker.

If your set is equipped with the receiver for NICAM reception, the high quality NICAM (Near Instantaneous Companding Audio Multiplex) digital sound can be received.

When NICAM mono is received, you can select **MONO** or FM MONO.

When NICAM stereo is received, you can select **STEREO** or FM MONO. If the stereo signal is weak, switch to FM mono.

When NICAM dual is received, you can select **NICAM DUAL A**, **NICAM DUAL B** or **NICAM DUAL AB** or **MONO**. When FM mono is selected the display **MONO** appears on the screen.

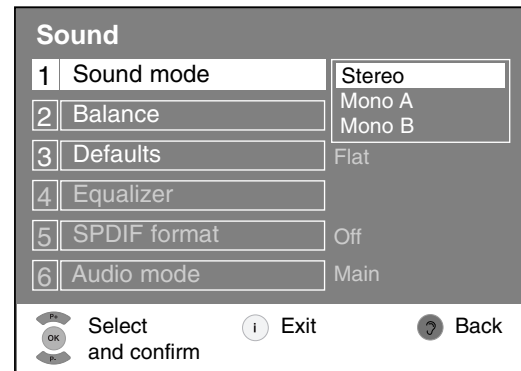
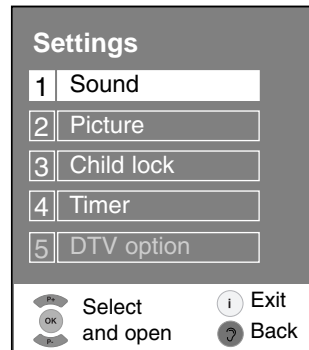
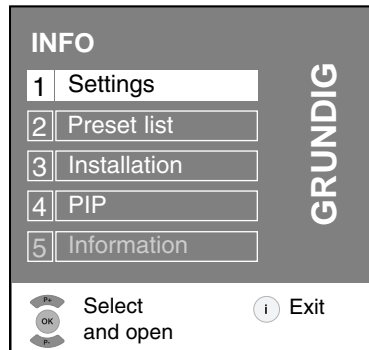

Setting up TV stations

Sound adjustment

2 Balance

Press the **i** button and then use **▲ / ▼** button to select the Settings menu.

Press the **OK** button and then use **▲ / ▼** button to select **Sound**.

Press the **OK** button and then use **▲ / ▼** button to select **Balance**.

Press the **OK** button and then use **◀ / ▶** button to make appropriate adjustments.

Press the **i** button to return to normal TV viewing.

3 Defaults

Press the **i** button and then use **▲ / ▼** button to select the Settings menu.

Press the **OK** button and then use **▲ / ▼** button to select **Sound**.

Press the **OK** button and then use **▲ / ▼** button to select **Defaults**.

Press the **OK** button and then use **▲ / ▼** button to select the desired sound item.

You can also recall a desired sound (**Flat, Music, Movie, Speech** or **User**) with **?** button on the remote control. The sound **Flat, Music, Movie** and **Speech** are programmed for good sound reproduction at the factory and cannot be changed.

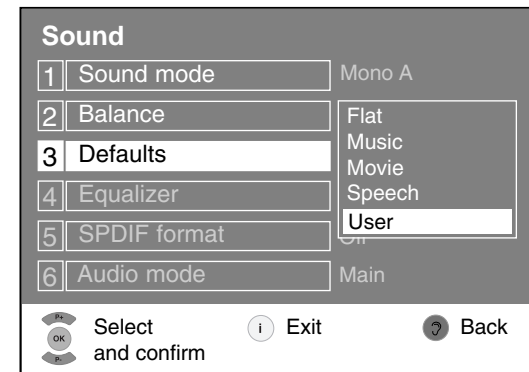
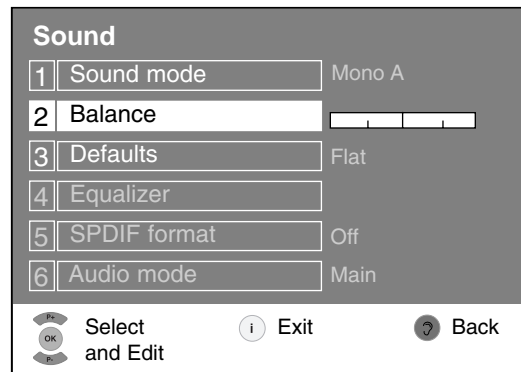

Setting up TV stations

Sound adjustment

4 Equalizer

Press the **i** button and then use **▲ / ▼** button to select the Settings menu.

Press the **OK** button and then use **▲ / ▼** button to select **Sound**.

Press the **OK** button and then use **▲ / ▼** button to select **Equalizer**.

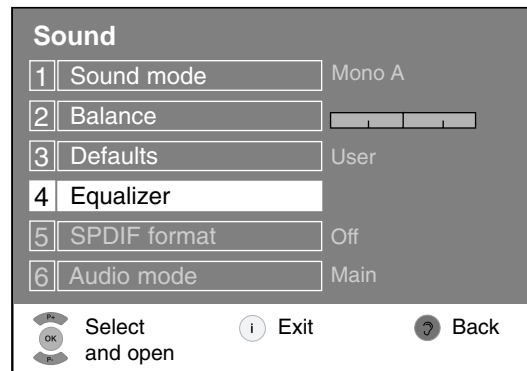

Press the **OK** button and then use **▲ / ▼** button to select the desired sound item.

Press the **OK** button and then use **◀ / ▶** button to make appropriate adjustments.

Press the **i** button to return to normal TV viewing.

Note : This function works in the User mode.

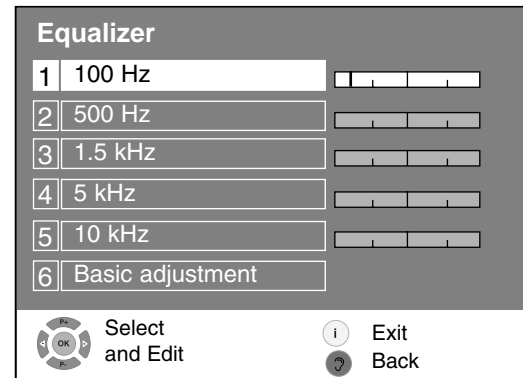

Setting up TV stations

Sound adjustment

5 SPDIF Format (in digital mode only)

Press the **i** button and then use **▲ / ▼** button to select the Settings menu.

Press the **OK** button and then use **▲ / ▼** button to select **Sound**.

Press the **OK** button and then use **▲ / ▼** button to select **SPDIF Format**.

Press the **OK** button and then use **▲ / ▼** button to select **AC-3** or **PCM**.

Press the **i** button to return to normal DTV viewing.

Note :

*a : It's available to use **AC-3** or **PCM** in Dolby Digital Audio signal.*

*b : When it doesn't apply the Dolby Digital Audio signal, select the **PCM** function to output the dolby digital audio by SPDIF output.*

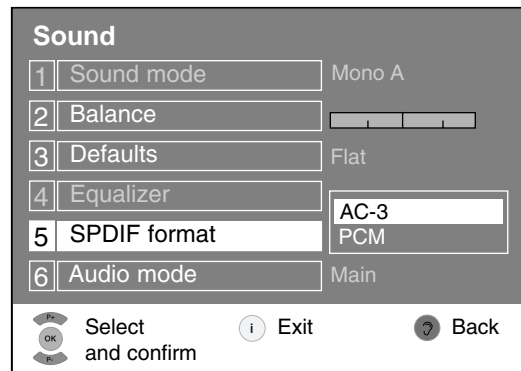

6 Audio Mode (in digital mode only)

This function lets you select your preferred language for audio.

Press the **i** button and then use **▲ / ▼** button to select the Settings menu.

Press the **OK** button and then use **▲ / ▼** button to select **Sound**.

Press the **OK** button and then use **▲ / ▼** button to select **Audio Mode**.

Press the **OK** button and then **▲ / ▼** button to select **Main** or **Sub**.

Press the **i** button to return to normal DTV viewing.

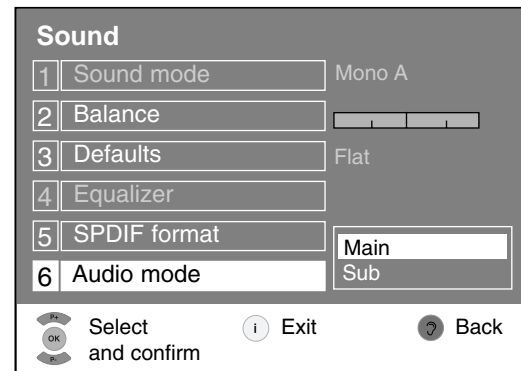

Setting up TV stations

Picture adjustment

1 Defaults

Press the **i** button and then use **▲ / ▼** button to select the Settings menu.

Press the **OK** button and then use **▲ / ▼** button to select **Picture**.

Press the **OK** button and then use **▲ / ▼** button to select **Defaults**.

Press the **OK** button and then use **▲ / ▼** button to select the desired picture option.

Press the **i** button to return to normal TV viewing.

You can also recall a desired picture (**Dynamic**, **Standard**, **Mild** or **User**) with **👁** button on the remote control. The picture **Dynamic**, **Standard**, **Mild** are programmed for good picture reproduction at the factory and cannot be changed.

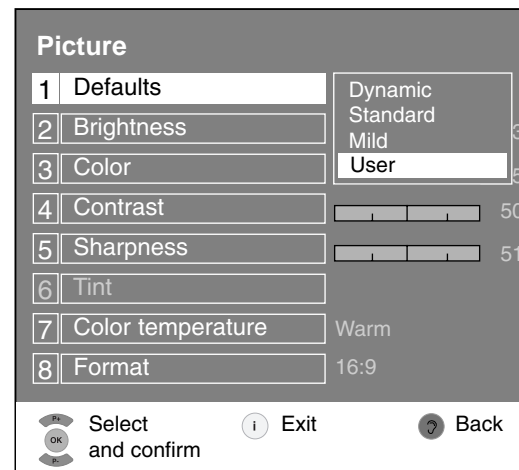
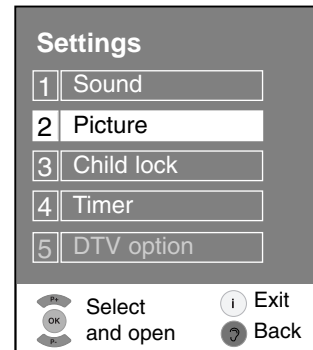
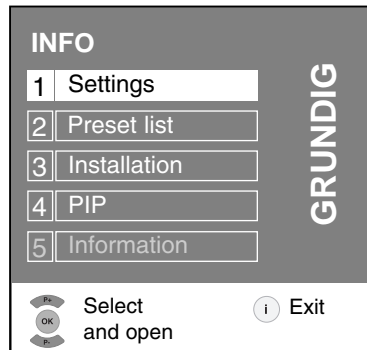

Setting up TV stations

Picture adjustment

2 Brightness

Press the **i** button and then use **▲ / ▼** button to select the Settings menu.

Press the **OK** button and then use **▲ / ▼** button to select **Picture**.

Press the **OK** button and then use **▲ / ▼** button to select the desired picture option.

Press the **OK** button and then use **◀ / ▶** button to make appropriate adjustments.

You can adjust picture contrast, brightness, colour, sharpness and tint (NTSC input only) to the levels you prefer.

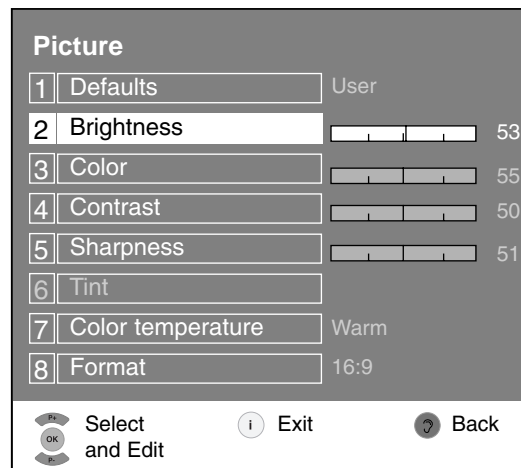

3 Color temperature

Press the **i** button and then use **▲ / ▼** button to select the Settings menu.

Press the **OK** button and then use **▲ / ▼** button to select **Picture**.

Press the **OK** button and then use **▲ / ▼** button to select **Color temperature**.

Press the **OK** button and then **▲ / ▼** button to select the desired colour temperature.

To initialize values (reset to default settings), select the **Normal** option.

Only User function ;

- Press the **▲ / ▼** button in **User**.
- Press the **▶** button and then use **▲ / ▼**, **◀ / ▶** button to make appropriate adjustments.

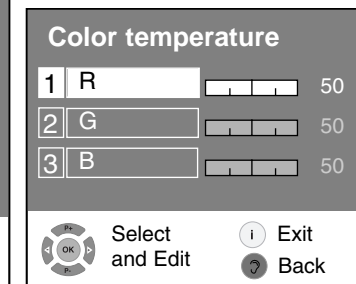
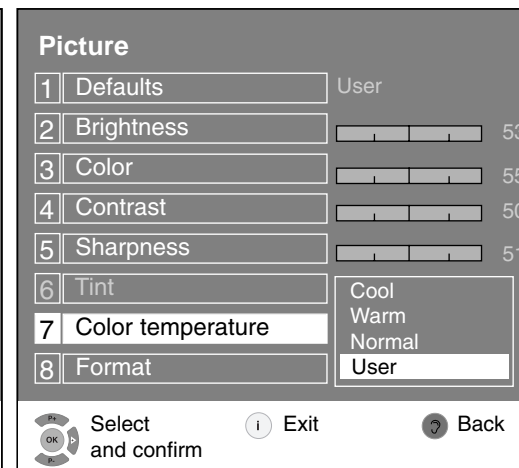

Setting up TV stations

Picture adjustment

4 Format

Press the **i** button and then use **▲ / ▼** button to select the Settings menu.

Press the **OK** button and then use **▲ / ▼** button to select **Picture**.

Press the **OK** button and then use **▲ / ▼** button to select **Format**.

Press the **OK** button and then use **▲ / ▼** button to make appropriate adjustments.

Press the **i** button to return to normal DTV viewing.

- You can only select 14:9, ZOOM, PANORAMA, AUTO in TV, AV1, AV2, S-VIDEO, COMPONENT [480i] mode only.

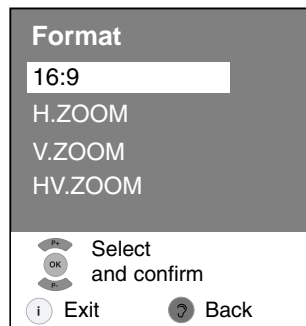
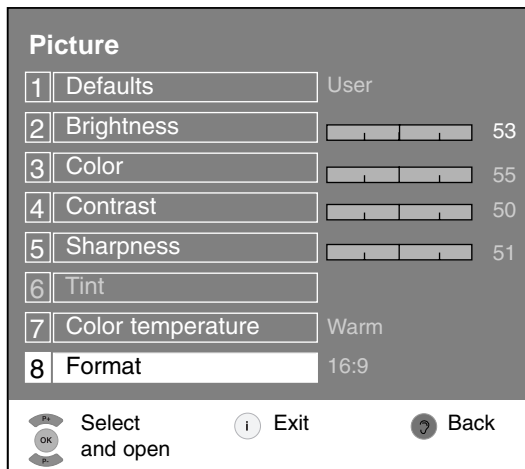
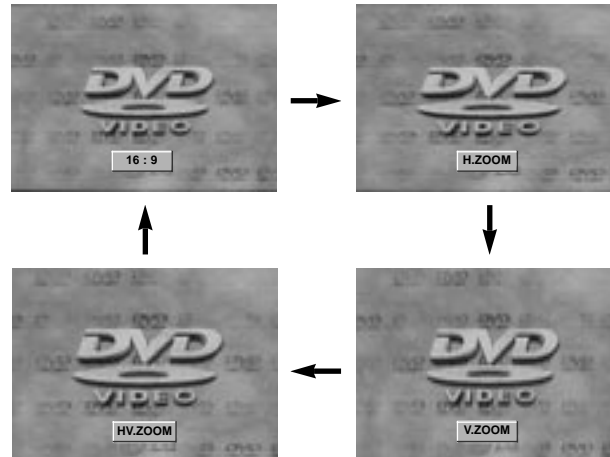

Setting up TV stations

Child lock

1 Child lock

Press the **i** button and then use **▲ / ▼** button to select the Settings menu.

Press the **OK** button and then use **▲ / ▼** button to select **Child lock**.

Press the **OK** button and then use **▲ / ▼** button to select **Off** or **On**.

Press the **i** button to return to normal TV viewing.

With the lock on, the display **Child lock on** appears on the screen if any button on the front panel is pressed while viewing the TV.

Note : The display **Child lock on** will not appear on the screen if any button on the front panel is pressed while displaying the menus.

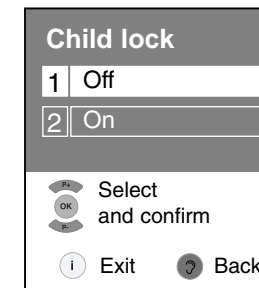
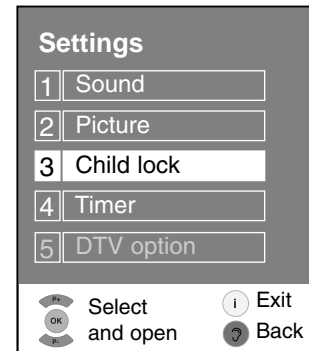
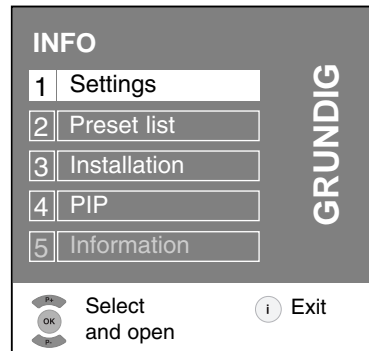

Setting up TV stations Timer

1 Clock

- Auto time is set automatically from a digital channel signal.

Press the **i** button and then use **▲ / ▼** button to select the Settings menu.

Press the **OK** button and then use **▲ / ▼** button to select **Timer**.

Press the **OK** button and then use **▲ / ▼** button to select **Clock**.

Press the **OK** button and then use **▲ / ▼** button to select **Auto** or **Manual**.

Only Manual function; Press the **▶** button and then **▲ / ▼** button to adjust hour and minute.

Press the **i** button to save.

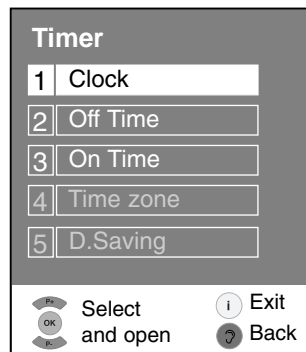
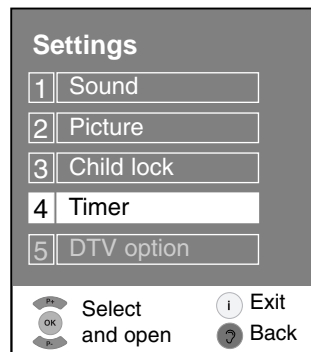
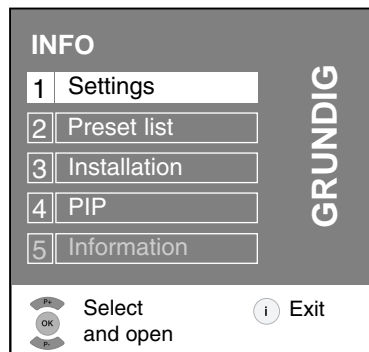



Setting up TV stations



Timer

2 On/Off Time



The off timer automatically switches the set to standby at the preset time.

Press the  button and then use  /  button to select the Settings menu.

Press the **OK** button and then use  /  button to select **Timer**.



Press the **OK** button and then use  /  button to select **Off Time** or **On Time**.

Press the **OK** button and then  /  button to select **On**.

To cancel **Off/On Time** function, press the  /  button to select **Off**.

Press the **OK** button and then  /  button to adjust the hour.

Press the  button and then  /  button to adjust the minute.

Only On time function; Press the  button and then  /  button to adjust volume level and program number.

Press the  to save.

Note :

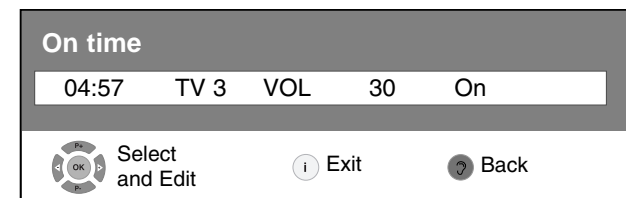
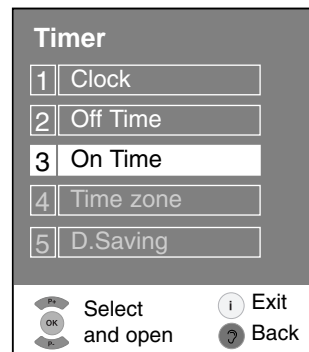
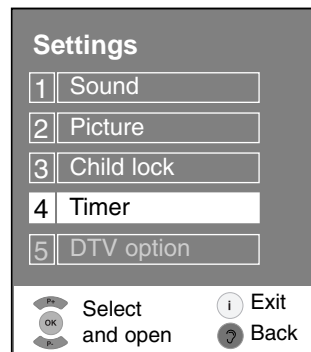

- a. In the event of power interruption (disconnection or power failure), the clock must be reset.
- b. Two hours after the set is switched on by the on time function it will automatically switch back to standby mode unless a button has been pressed.
- c. Once the on or off time is set, these functions operate daily at the preset time.
- d. Off Timer function overrides On Timer function if they are set to the same time.
- e. The set must be in standby mode for the On Timer to work.



Setting up TV stations Timer



3 Time zone (in digital mode only)

The digital channel signal includes information for the current time provided by the broadcasting station.

Press the  button and then use  /  button to select the Settings menu.

Press the **OK** button and then use  /  button to select **Timer**.



Press the **OK** button and then use  /  button to select **Time zone**.

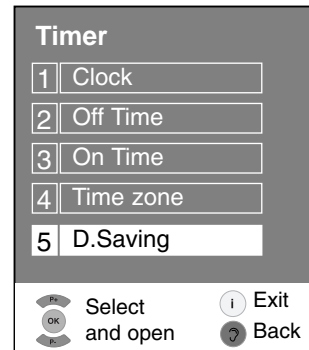
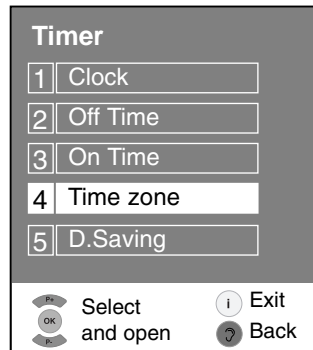

Press the **OK** button and then  /  button to select your viewing area time zone : **NSW/ACT**, **VIC/TAS**, **QLD**, **SA**, **WA**, **NT**, **Auto time zone**.



Press the  button to return to normal DTV viewing.



4 D. Saving

Press the  button and then use  /  button to select the Settings menu.

Press the **OK** button and then use  /  button to select **D. Saving**.

Press the **OK** button and then use  /  button to select **On** or **Off**.

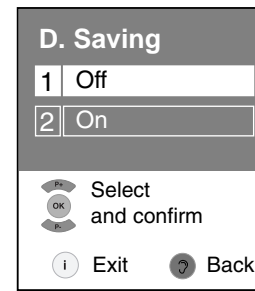

Press the  button to return to normal DTV viewing.







DTV option Menu (in digital mode only)

1 Rating

Parental Control can be used to block specific channels, ratings and viewing sources.



Press the  button and then use  /  button to select the Settings menu.

Press the **OK** button and then use  /  button to select **DTV option**.

Press the **OK** button and then use  /  button to select **Rating**.

Press the **OK** button to enter the password as requested.

The TV is set with the initial password "0-0-0-0".

Press the  /  button to select type of ratings to block .

Press the  button to return to normal DTV viewing.

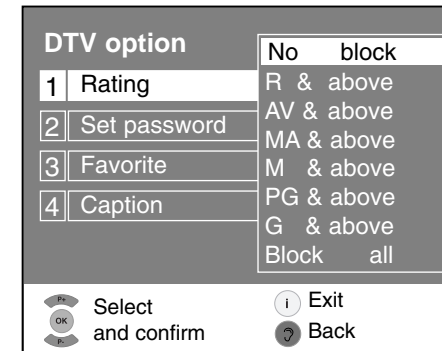
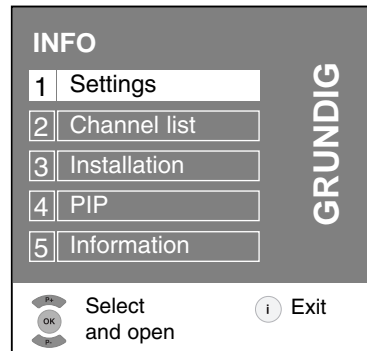

DTV option Menu (in digital mode only)



2 Rating menu option



- **No Block**
All programs can be watched because there is no age limitation.
- **R & Above (Restricted 18+)**
Programs are blocked for children under the age of 18.
- **AV & Above (Adult Audience strong violence 15+)**
This program contains the strong violent contents. Therefore, programs are blocked for children under the age of 15
- **MA & Above (Mature Adult Audience 15+)**
Programs are blocked for children under the age of 15.
- **M & Above (Mature Audience 15+)**
Programs are blocked for children under the age of 15.
- **PG & Above (Parental Guidance Recommended)**
This programs contains unsuitable materials that parents want to prevent their children from watching.
- **G & Above (General Audience)**
This programs is designed to be appropriate for all ages.
- **Block All**
All programs are blocked without considering the age level.

DTV option Menu (in digital mode only)

3 Set password

Change the password by inputting a new password twice.

Press the  button and then use  /  button to select the Settings menu.

Press the **OK** button and then use  /  button to select **Set password**.

Press the **OK** button to enter the password as requested.

The TV is set with the initial password "0-0-0-0".

Press the **OK** button and then enter a four digit password.

Enter it again when requested.

Press the  button to return to normal DTV viewing.

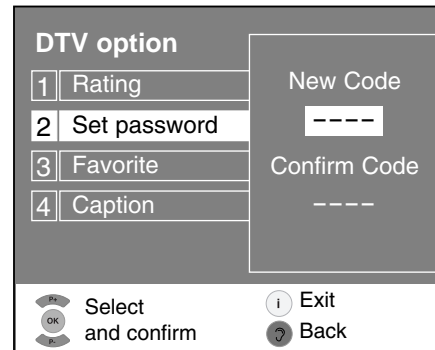
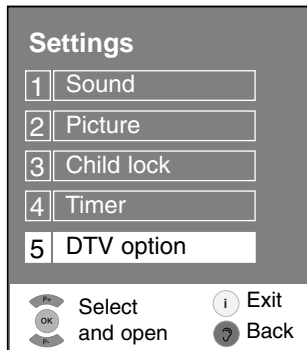

DTV option Menu (in digital mode only)

4 Favorite

This function lets you select your favourite programmes directly.

Press the **i** button and then use **▲ / ▼** button to select the Settings menu.

Press the **OK** button and then use **▲ / ▼** button to select **Favorite**.

Press the **OK** button and then use **▲ / ▼** button to select **On** or **Off**.

Press the **i** button to return to normal DTV viewing.

5 Caption

Press the **i** button and then use **▲ / ▼** button to select the Settings menu.

Press the **OK** button and then use **▲ / ▼** button to select **Caption**.

Press the **OK** button and then use **▲ / ▼** button to select **On** or **Off**.

Press the **i** button to return to normal DTV viewing.

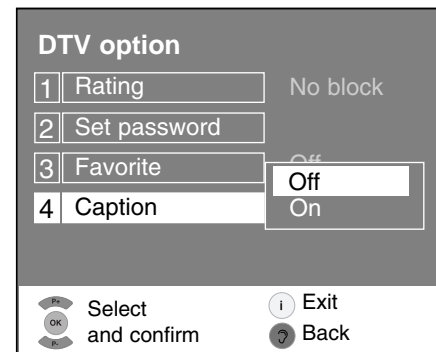
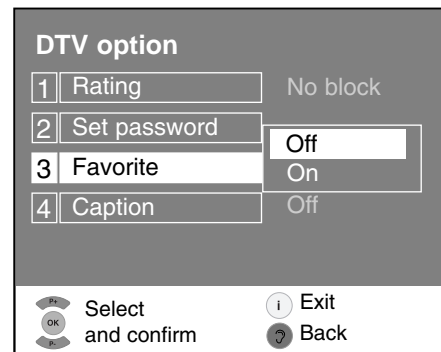
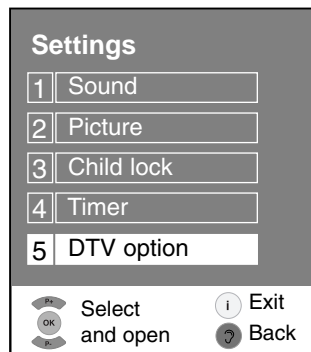

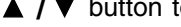

Preset list Menu

- This function enables you to delete or skip the stored programmes. Also you can move some stations to other programme numbers or insert a blank station data into the selected programme number.

Press the  button and then use  button to select the Preset list menu.



Press the **OK** button to display the **Preset list** menu.

Deleting a programme

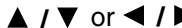

Select a programme to be deleted with the  or  button.

Press the  button twice. The selected programme is deleted, all the following programmes are shifted up one position.

Moving a programme

Select a programme to be moved with the  or  button.

Press the  button.

Move the programme to the desired programme number with the  or  button.

Press the  button again to release this function.

< Analogue mode edit >

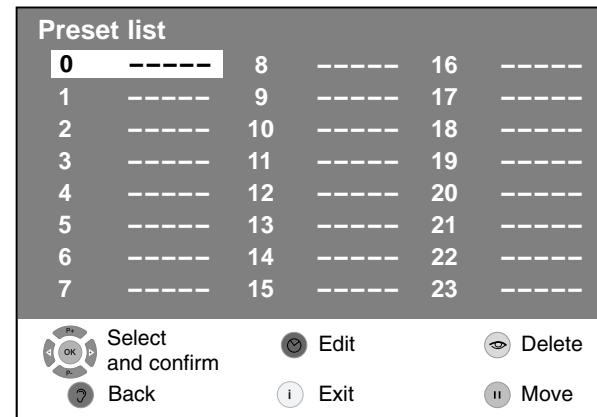
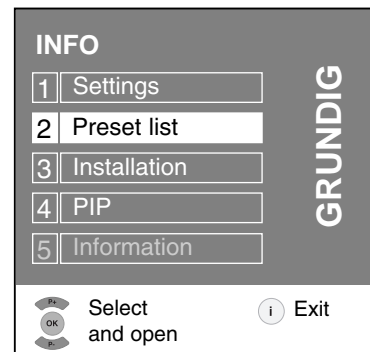

< Digital mode channel list >

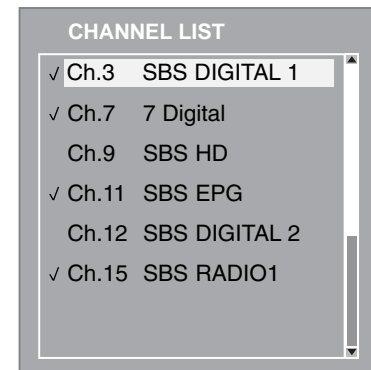

1 Edit a programme

Select a programme to be deleted with the ▲ / ▼ or ◀ / ▶ button.

Press the Ⓞ button to display the **Edit channel settings** menu.

Press the ▲ / ▼ button to select **Edit name**.

Press the **OK** button.

Press the ▲ button. You can use a blank, +, -, the numeric **0** to **9** and the alphabet **A** to **Z**.

With the ▼ button you can select in the opposite direction.

Select the position by pressing the ◀ / ▶ button and then take your choice of the second character, and so on.

Press the ▲ / ▼ button to select **Type**.

Press the **OK** button and then ▲ / ▼ button to select **V/UHF** or **CABLE**.

Normally fine tuning is only necessary if reception is poor.

Press the ▲ / ▼ button to select **Finetuning**.

Press the **OK** button.

Press the ◀ / ▶ button to fine tune for the best picture and sound.

Edit channel settings ()

1	Edit name	
2	Type	VHF/UHF
3	Channel entry	21
4	Finetuning	0
5	TV standard	DK
6	Color standard	Automatic

Ⓞ Select and open ⓘ Exit Ⓞ Back

Edit channel settings ()

1	Edit name	VHF/UHF
2	Type	CABLE
3	Channel entry	21
4	Finetuning	0
5	TV standard	DK
6	Color standard	Automatic

Ⓞ Select and confirm ⓘ Exit Ⓞ Back

Edit channel settings ()

1	Edit name	
2	Type	VHF/UHF
3	Channel entry	21
4	Finetuning	0
5	TV standard	DK
6	Color standard	Automatic

Ⓞ Select and Edit ⓘ Exit Ⓞ Back

Preset list Menu

2 TV standard

Press the ▲ / ▼ button to select **TV standard**.

Press the **OK** button and then use ▲ / ▼ button to select **BG, I, DK, L**.

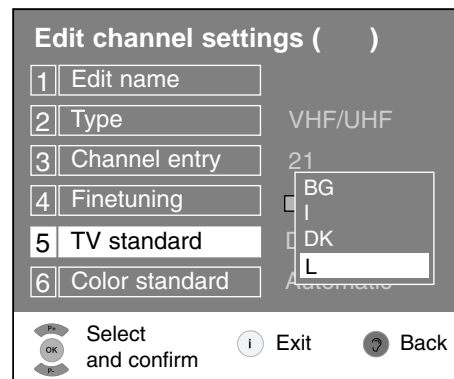

3 Color standard

Press the ▲ / ▼ button to select **Color standard**.

Press the **OK** button and then use ▲ / ▼ button to select **Automatic, PAL BG/H/I, SECAM, NTSC4.43**.

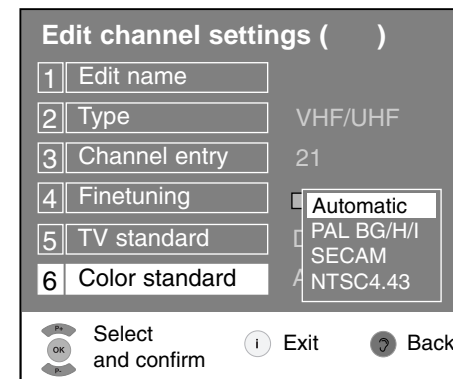

Stations can be tuned using automatic or manual modes.

- All stations that can be received are stored by this method. It is recommended that you use auto programme during installation of this set.

1 Station search

Press the  button and then use **▲ / ▼** button to select the Installation menu.

Press the **OK** button and then use **▲ / ▼** button to select **Station search**.

Press the **OK** button and then use **▲ / ▼** button to select **TV search, DTV search, All search**.

Press the **OK** button.

Press the **OK** button to begin auto programming.

Press the **OK** button to begin auto programming. All receivable stations are stored.

To stop auto programming, press the  button. When auto programming is completed, the **Preset list** menu appears on the screen. See the 'Preset list' section to edit the stored programme.

Press the  button to return to normal TV viewing.

Note : *The auto search operation all data is deleted.*

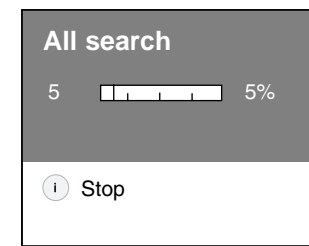
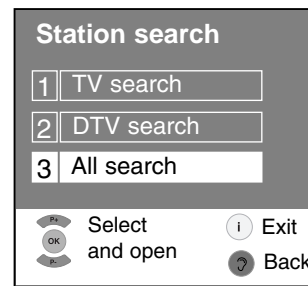
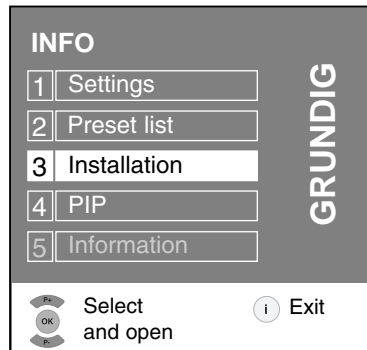

Sleep timer



You don't have to remember to switch the set off before you go to sleep. The sleep timer automatically switches the set to standby after the preset time has elapsed. Press the **-/--** button to select the number of minutes. The display '**---min**' will appear on the screen, followed by **10**, **20**, **30**, **60**, **90**, **120**, **180** and **240**. The timer begins to count down from the number of minutes selected.



Note :



- a. To view the remaining sleep time, press the **-/--** button once.
- b. To cancel the sleep time, repeatedly press the **-/--** button until the display '**---min**' appears.
- c. When you switch the set off, the set releases the preset sleep time.



PC Setup

You can adjust horizontal/vertical position, clock, phase, and auto-configure, reset as you prefer.

Press the  button and then use  /  button to select the Installation menu.

Press the **OK** button and then use  /  button to select **PC Control**.

Press the **OK** button and then  /  button to select the desired picture item.

Press the  /  button to make appropriate adjustments.

H-Position / V-Position

This function is to adjust picture to left/right and up/down as you prefer.

Clock

This function is to minimize any vertical bars or stripes visible on the screen background. And the horizontal screen size will also change.

Phase

This function allows you to remove any horizontal noise and clear or sharpen the image of characters.

Auto-configure

This function is for the automatic adjustment of the screen position, clock and phase. The displayed image will disappear for a few seconds while the Auto-configuration is in progress.

Reset

This function allows you to return to the good picture reproduction programmed at the factory and cannot be changed.

Note : Some signal from some graphics boards may not function properly. If the results are unsatisfactory, adjust your monitor's position, clock and phase manually.

Press the **OK** button to store it for the PC monitor picture. Press the  button to return to PC mode.

WXGA (or VGA (Only RGB/HDMI mode))

a : When the set is inputted WXGA signal, select the desired WXGA resolution.

b : When the set is inputted HDMI-480p signal in VGA mode, select 480p on the Installation menu.

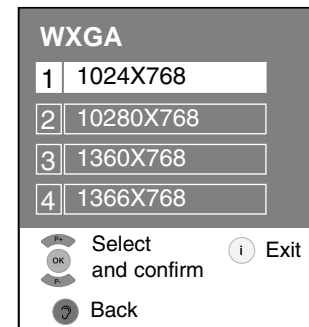
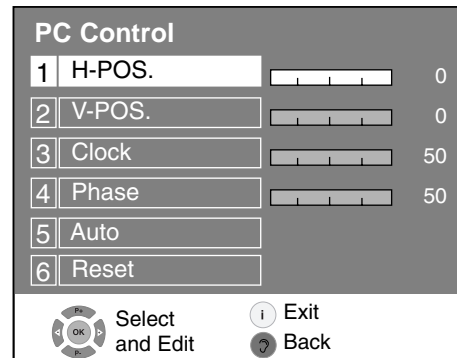

PIP (Picture-in-Picture) Feature

- PIP lets you view 2 different inputs (sources) on your monitor screen at the same time. One source will be large, and the other source will show a smaller inset image.

1

Watching PIP

Press the **PIP** button to show the sub picture.

- Each press of **PIP** button changes the screen display as shown below.
- It's not available to use 1080i in COMPONENT, PC, HDMI mode.

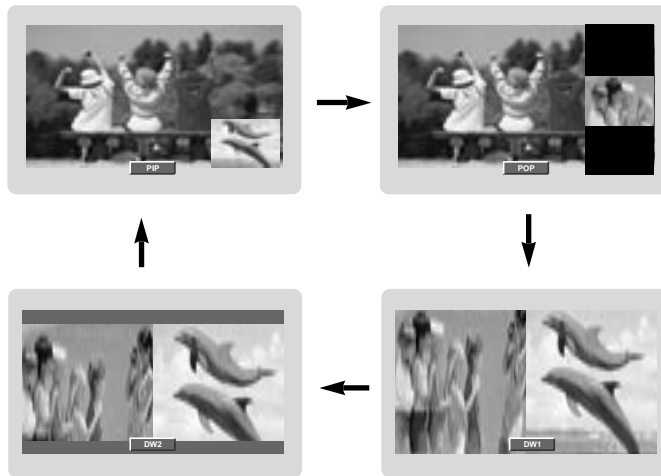

2

PIP Audio Input

PIP mode - main and sub picture audio select.

Press the **i** button and then **▲** / **▼** button to select the PIP menu.

Press the **OK** button and then **▲** / **▼** button to select **Audio Input**.

Press the **OK** button and then **▲** / **▼** button to select **Main** or **Sub**.

Press the **i** button to return to normal TV viewing.

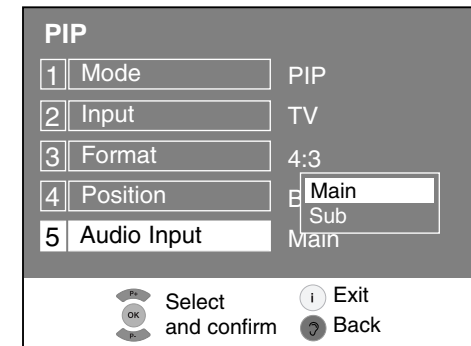

3 Moving the PIP

Press the **POS** button.

Press the **POS** button repeatedly until desired position is achieved. The sub pictures move clockwise.

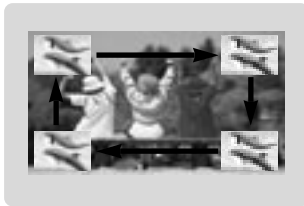

4

Sub picture size

Press the **SIZE** button to select the desired sub picture size. The sub picture appears as 1/9 size of the main picture, followed by 1/16.

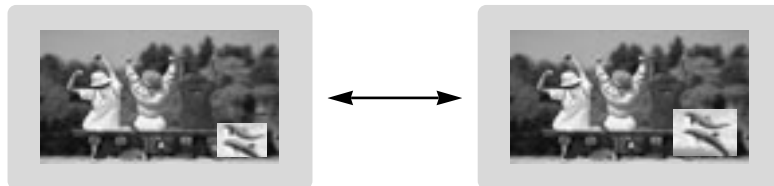

5

Programme scan

This function enables you to search all the stored stations on 4 or 16 sub pictures and see your favourite station by exchanging the main and sub pictures.

Press the **SCAN** button repeatedly to select POP4/POP16.

The selected sub or main pictures search all the stored stations.

Press the **i** button to switch off sub or main pictures.



Information Menu (In Digital mode only)

1 Information

- This function shown the present screen information.

Press the **i** button and then **▲ / ▼** button to select the Information menu.

Press the **OK** button and then **▲ / ▼** button to select **Information**.

Press the **OK** button.

The service information appears on screen.

Press the **i** button to return to normal DTV viewing.

Note :

a When you press the **OK** button, **Signal Strength** aren't displayed on the information OSD.

b It's disappeared after a while.

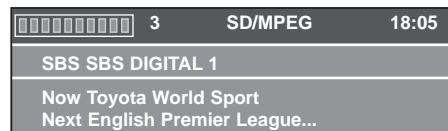

2 TV Guide

- This function shown the interactive programme guide.

Press the **i** button and then **▲ / ▼** button to select the Information menu.

Press the **OK** button and then **▲ / ▼** button to select **Information**.

Press the **OK** button.

The TV Guide information appears on screen.

Press the **i** button to return to normal DTV viewing.

Press the **SCAN** button to display the DTV Guide.

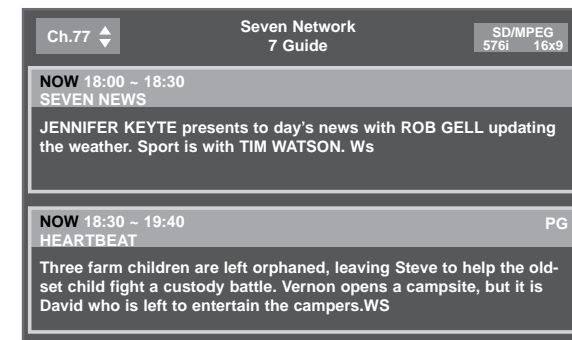

Teletext (or TOP text) is an optional function, therefore only a set with the teletext system can receive the teletext broadcast.

Teletext is a free service broadcast by most TV stations which gives up-to-the-minute information on news, weather, television programmes, share prices and many other topics.

The teletext decoder of this TV can support the SIMPLE, TOP and FASTEXT systems. SIMPLE (standard teletext) consists of a number of pages which are selected by directly entering the corresponding page number. TOP and FASTEXT are more modern methods allowing quick and easy selection of teletext information.

Switch on/off

Press the **TEXT** button to switch to teletext.

The initial page or last page appears on the screen.

Two page numbers, TV station name, date and time are displayed on the screen headline. The first page number indicates your selection, while the second shows the current page displayed.

Press the **TEXT** button to switch off teletext. The previous mode reappears.

SIMPLE text

Page selection

1. Enter the desired page number as a three digit number with the NUMBER buttons. If during selection you press a wrong number, you must complete the three digit number and then re-enter the correct page number.
2. The **▲ / ▼** button can be used to select the preceding or following page.

Programming a colour button in LIST mode

If the TV is in SIMPLE text, TOP text or FASTEXT mode, **POS** press the button to switch to LIST mode.

Four teletext page numbers of your choice can be colour coded and easily selected by pressing the corresponding coloured button on the remote control handset.

1. Press a coloured button.
2. Using the NUMBER buttons, select the page you wish to programme.
3. Press the **OK** button. The selected page is stored as the selected page number, blinking once to confirm this. From now on, you can select this page with the same coloured button.
4. The three other coloured buttons are programmed in this way.

TOP text (option)

The user guide displays four fields-red, green, yellow and blue at the bottom of the screen. The yellow field denotes the next group and the blue field indicates the next block.

Block / group / page selection

1. With the blue button you can progress from block to block.
2. Use the yellow button to proceed to the next group with automatic overflow to the next block.
3. With the green button you can proceed to the next existing page with automatic overflow to the next group.
Alternatively the ▲ button can be used.
4. The red button permits to return to previous selection.
Alternatively the ▼ button can be used.

Direct page selection

Corresponding to the SIMPLE teletext mode, you can select a page by entering it as a three digit number using the NUMBER buttons in TOP mode.

FASTTEXT

The teletext pages are colour coded along the bottom of the screen and are selected by pressing the corresponding coloured button.

Special teletext functions

SCAN

Press this button to display concealed information, such as solutions of riddles or puzzles.
Press this button again to remove the information from the display.

SIZE

Selects double height text.

Press this button to enlarge the top half of the page.

Press this button again to enlarge the bottom half of the page.

Press this button again to return to the normal display.



Stops the automatic page change which will occur if a teletext page consists of 2 or more sub pages. The number of sub pages and the sub page displayed is, usually, shown on the screen below the time. When this button is pressed the stop symbol is displayed at the top left-hand corner of the screen and the automatic page change is inhibited.

To continue press this button again.

PAP

Displays the teletext pages superimposed on the TV picture.

To switch the TV picture off press this button again.

-/--

In the teletext mode, press this button to select a sub page number. The sub page number is displayed at the bottom of the screen. To hold or change the sub page, press the RED / GREEN, ▲ / ▼ or NUMBER buttons.

Press this button again to exit this function.

Displayable Monitor Specification

RGB Mode / HDMI Mode

MODE	Resolution	Horizontal Frequency (KHz)	Vertical Frequency (Hz)
DOS	640X350	31.5	70.0
	720X400	31.5	70.0
VGA	640X480	37.9	85.0
		31.5	60.0
		37.8	72.0
		37.5	75.0
SVGA	800X600	43.2	85.0
		35.1	56.0
		37.9	60.0
		48.0	72.0
XGA	1024X768	46.9	75.0
		53.7	85.0
		48.4	60.0
		56.4	70.0
SXGA	1280X1024	60.0	75.0
		60.0	85.0
		63.9	60.0
		75.0	70.0
WXGA	1280X768	79.9	75.0
		91.1	85.0
		47.7	60.0
	60.1	75.0	
UXGA	1360X768	68.5	85.0
	1366X768	49.0	60.0
UXGA	1600X1200	49.0	60.0
MAC	832X624	75.0	60.0
		49.7	75.0

(Synchronization input form : separate)

Note:

- If the set is cold, there may be a small "flicker" when the set is switched on. This is normal, there is nothing wrong with the set.
- If possible, use the VESA 1,024x768@60Hz video mode to obtain the best image quality for your LCD monitor. If used to PC vertical frequency 85Hz, some noise can be seen when PIP is on. In this case, set the PC vertical frequency to 60Hz. The set has been pre-adjusted to the mode VESA 1,024x768@60Hz.
- Some dot defects may appear on the screen, like Red, Green or Blue spots. However, this will have no impact or effect on the monitor performance.
- Do not press the LCD screen with your finger for a long time as this may produce some temporary distortion effects on the screen.
- When the PC screen appears on the set, a message may appear on the screen, and the message will differ according to the Window system version (Win98, 2000). If a message appears click "Next" until the message finishes.
- If the message "**Out Of Range**" appears on the screen, adjust the PC as in the 'Displayable Monitor Specification' section.

Note

